

Foreword

Scope of this manual

This manual contains the specifications, functional description, operating instructions, schematic, parts locator and parts list for the 2012 mobile data terminal.

This manual is intended for use by qualified service technicians to aid them with installation, interfacing, alignment and trouble shooting of the 2012 when used with other land mobile radios.

Service manual revisions

Component changes, additions and deletions may occur in the circuit design to improve operation and will be reflected in future releases of this service manual. Specifications and circuit changes are subject to change without prior notice or obligation by Pyramid Communications.

Safety Information

The 2012 is designed to operate within all applicable Federal regulations at the time of manufacture. Proper operation and service procedures will assure continued compliance with these regulations:

- Do not operate the 2012 in the presence of unshielded electrical blasting caps or explosive environmental conditions.
- Do not operate the 2012 while refueling the vehicle or in the presence of explosive fumes.

Specifications

General:

Operation: 18 key; 10 status, 5 function, emergency and cursor keys.
Display: 2x16 back lit LCD .365" character height.
Status Tags: PC programmable with FY-1 cable
Messaging: 16 characters (DTMF mode) or 64 characters (MSK mode)
Storage: Non-volatile E²PROM with 100 year data retention.
Interface: *Radio:* DB9M
Data bus : DB9F
GPS Ant : SMA female
Data Bus: RS-485 9600 baud bi-directional multi-addressing
Application: Conventional and Trunking mobiles
Diagnostics: Keypad, encoder, decoder, GPS receiver, and E²PROM.
Adjustments: Rx Sensitivity, Tx Deviation, Squelch threshold.

Power Requirements:

DC Supply 13.6VDC negative ground \pm 25%. 400 mA nominal

Physical:

Dimensions: 5.75" L x 4.5" H x 1.5" D.
Weight: 14 oz.
Case: Extruded Aluminium.
Keyboard: 18 Key snap dome sealed membrane type.

Encoder :

Format: Dual Mode: MPT-1317¹ and DTMF
Speed: 1200/2400 Baud MSK and 18.2 DPS DTMF 3:1 tone:space (41.33mS:13.66mS)
PTT Delay: .1-2.5 Sec in 100 mSec steps + smart trunking access
Tx Audio: 0-2.5 VRMS 2.2K Ohms, AC coupled

Decoder :

Format: Dual Mode: MPT-1317¹ and DTMF
Speed: 1200/2400 Baud MSK and 18.2 DPS DTMF
Rx Audio: Hi-Z (100k Ohm) AC coupled to discriminator
Level: 20mV - 10V RMS
DTMF twist: 12db
CTCSS Reject: -36db @ 74 Hz

Output :

PTT: Active Low 300 mA open collector
Audio Mute: Active Low 100 mA open collector
Mic Mute: Active Low 100 mA open collector
Horn Honk: Active Low 2A open collector diode protected

GPS:

Receiver Board: Ashtech (Magellen) G8 NMEA-0183 V2.1 8 channel receiver
Antenna Conn.: SMA female
Antenna: Active LNA type, minimum 10db gain 5VDC @ 20 mA, SMA male connector

specifications subject to change without notice

Functional Description

The Pyramid Communications Model 2012 is a microprocessor controlled MSK/DTMF status reporter capable of signalling the dispatcher with 10 individual status indications plus emergency. By pressing one of the 10 status keys on the front panel, the vehicle number, console routing information, and new status are automatically sent via two way radio to the dispatch console. The base equipment will automatically respond with the proper acknowledgment and the mobile unit will update the display to the current status. The model 2012 will monitor the channel for activity or properly acquire a voice channel (if installed on a trunking system) before transmitting its message. The model 2012 will also automatically retry its message if the acknowledgment from the base is not received within 6 seconds. The number of retries and PTT delay are PC programmable.

The base equipment may also selectively call a mobile or group of mobiles, interrogate a mobile for its current status, honk a vehicle horn (or group of vehicles), or reassign a mobile to a different console all without the intervention of the mobile user.

When used in MSK signalling mode, additional data messaging and GPS Automatic Vehicle Location capabilities are possible. Refer to page 14 for a complete description of GPS operation.

The model 2012 is completely programmable for all operating parameters via IBM compatible PC; see page 10 for programming details.

The model 2012 also has a built in self test for diagnostics and alignment which can be accessed through the front panel keyboard without any tools. All internal adjustments are accessible by removing the right hand side panel. All alignment and testing can be done in the vehicle with minimum effort.

Status Reporting:

When the mobile user presses one of the 10 status buttons, the display will show the current status, the second line will show "Sending..." to display the new status request. The model 2012 will monitor the channel for activity and will hold off sending its message until the channel is clear. While waiting to transmit, the display will continue to show the "Sending..." status until the channel is clear for transmission, or the unit times out. If unable to transmit within 60 seconds, the user will get an error indication (3 beeps) and the display will return to the previous current status.

If the channel is clear for transmission of the status message, the model 2012 will key the radio for the PTT delay time (conventional operation) then send the message. On trunking systems, the model 2012 will key the radio while monitor the radio's transmitter for an on-air condition. If it does not see the radio transmit at all (system is busy for instance) it will retry every 5 seconds until successful or time out (60 seconds). When it detects that the radio is transmitting, it will continue to monitor the on-air line until the transmitter has remained on the air long enough to indicate it has acquired a voice channel. After successful acquisition of a voice channel, it will send its status request.

After a status request is sent, it will monitor the channel for the proper acknowledgment. If it does not receive the ack message from the base within 6 seconds, it will repeat the above sequence until the number of retries expires, or it is successful. If successful, the display will show the new status showing. If unsuccessful, the display will show the previous status, and the user will hear the 3 error beeps.

The model 2012 will save the last *current* status in E²PROM, so the unit will always come on in the last status that was selected before power off.

If the user presses the Dispatch Request key (0), the model 2012 will send out the proper message sequence as above, but the base is not required to automatically respond, so the display will revert to the previous status as soon as the unit successfully transmits the request. If unable to send the request (60 second time out) the user will get the 3 error beeps as above.

Keypad

Reset : Pressing the *RESET* key will interrupt any operation and return to the idle state with the display showing an indication of the current status. Reset will cancel a status request, a selective call indication, or stop the horn from honking (in traffic for instance). The user will also hear 3 short beeps indicating ready condition.

Clear : Used only for MSK mode, pressing *Clear* will reset the pencil icon after a data message has been received.

Enter : Used only for DTMF mode, pressing *Enter* will save a data message that has just been received.

F1: In normal mode, recalls a previously saved data message and display it on the LCD (DTMF or MSK mode). If held while applying power, enters the programming mode (see page 10 for details).

F2: In normal mode, toggles the state of the Horn Honk enable (to prevent honking the horn in traffic). If enabled, the "  " icon appears above the "SPC" window in the bottom display line. If held while applying power, enters the technician test mode (see pages 8 and 13 for details).

Emg: Will cause the 2012 to send an emergency status to the dispatch console indicating that there is an emergency situation. The display will change to "*** EMERGENCY! ***" indicating the current status.

Up/Down Arrows : Used only in MSK mode, will scroll the LCD display if a data message has been recalled.



ANI : The model 2012 can be configured to send the vehicle number automatically every time the radio operator presses the mic PTT button. The on-air detect line is used to trigger the ANI sequence. The model 2012 will wait for the PTT delay time or until the radio acquires a voice channel if programmed for trunking, before sending the ANI sequence.

Time Stamp : If time stamping is enabled, the status message has two digits appended to the message to indicate when the status key was actually pressed. If the vehicle is within range of the base (2012 is receiving acknowledgments to status requests) the time stamp is 00. If the vehicle drives out of range, status requests are queued and are sent when the vehicle is back in range of the base. The 2 digit time stamp indicates the number of minutes since the button was actually pressed. Time stamping can be enabled or disabled by the PC in DTMF mode. In MSK mode, time stamping is always enabled.

Icons

The following icons are displayed on the bottom line of the LCD to indicate various operating states:

SPC : The horn icon () indicates whether the horn honk feature is enabled or not and can be toggled by the user by pressing F2.

GPS : The arrow icon () indicates if the GPS option is installed, but a position fix has not been acquired. When the GPS receiver acquires a position lock, the icon changes to the satellite dish ().

A/P : Accessory/Printer icon. Not currently supported.

RNG : The range icon () indicates when the vehicle is out of range, determined by whether the 2012 received an acknowledgment to a status request. If out of range is indicated, all further status requests are immediately queued.

MSG : The pencil icon () indicates when a data message has been received but not saved.

Console functions

Individual Call: The dispatcher may selectively call a vehicle in the system either in response to a dispatch request, or to alert a mobile user who has left their vehicle that they have been paged. The individual model 2012 that has decoded a selective call will beep continuously, once per second, and display a "Paged" until the mobile user presses any key. The model 2012 will automatically respond with an acknowledgment to an individual call alert without intervention by the user, following the method outlined above.

Group Call: The dispatcher may alternately choose to alert a group of vehicles by substituting the “#” wild card digit for any or all of the numbers in the vehicle code (DTMF mode) or by entering "GROUP" as the vehicle number (MSK mode). The mobiles who are group called are not required to respond automatically. The model 2012 will accept group call functions for alert, horn honk, and assign console.

Auto Interrogate: The dispatcher may selectively interrogate an individual mobile for its current status. The model 2012 will send its current status without intervention from the user, as above. In MSK mode, the dispatcher may also interrogate the GPS receiver for its current position.

Horn Honk: If the dispatcher wishes to signal a user who is out of his vehicle, he may do so by sending a horn honk sequence. The model 2012 will automatically acknowledge as above, then honk the vehicle horn 5 times for one second each time. The horn honk feature can be enabled/disabled by the mobile user, so that the horn would not be set off inadvertently in traffic. The model 2012 stores the status of the horn honk enable/disable in E²PROM so the user will not have to enable it every time the vehicle is started or power is turned off. The model 2012 will accept a group horn honk. Function key F2 toggles the horn honk enable/disable feature.

Assign Console : The mobile message that is sent out contains a routing code which assigns it to one of up to 4 dispatch consoles. The current dispatcher may reassign the mobile to another dispatcher over the air by sending the proper sequence. The model 2012 will automatically respond as above, then change its routing code to the new console assignment, and begin monitoring signalling from only that console. The model 2012 will accept group reassignments.

Installation

The model 2012 can be configured for use with conventional or trunking systems. The minimum interface required is 5 wires for conventional operation and 6 wires for trunking. There are also 3 optional connections that allow for features such as microphone muting, and tone stripping (audio muting during the reception of messages) and busy channel lockout.

P1 (DB9-M) Radio Connector

Pin 1: Ground. Connect to the radio ground
(Shield/Black)

Pin 2: Transmit Audio Out. This is the DTMF/MSK encode line to the radio. It is approximately 2.2K Ohms, AC coupled and should be connected to the input of the microphone bandpass filtering *before pre-emphasis and limiting*. If connected too close to the microphone input, it may reduce the amount of mic audio; if connected too far into the transmit audio circuitry, you may not be able to achieve enough modulation. *It is important that the transmitted signal does not get distorted*. Excessive distortion will affect the reliability of the received signal and may be responsible for retries and failed status requests.

Pin 3 : On-Air detect input. In trunking applications, this line should be connected to radio logic level that indicates that the radio is transmitting. *This is not the same as mic PTT*. On trunking logic boards, this line would be radio PTT, or connect directly to the Tx LED. The line can be either active high or active low. Program "On Air Polarity" to "Low" if the line goes to ground during transmit, to "High" if the line goes positive during transmit. ***Do not install J2 for trunking applications.***

In conventional applications, this line is used as the ANI trigger and can be the same as mic PTT. Installing J2 will connect this line to the PTT output (pin 4).

Pin 4 : PTT output. This is an open collector output to the radio and should be connected to the mic
(Green) PTT line.

Pin 5 : Switched 13.6VDC from the radio. This line *must* go off when the radio is switched off, since
(Red) the model 2012 does not have a power switch. It should be capable of supplying at least 500mA.

Pin 6 : Receive audio input. Connect this line *directly to the output of the radio's discriminator*. Do
(Yellow) *not* connect to any point after filtering or de-emphasis. It is a high impedance input (100KOhms) and AC coupled.

Pin 7 : Busy Channel Input. This line is connected to the logic level output that indicates that the radio
(Violet) is receiving and audio is unmuted. The COR polarity can be programmed to be active high or active low. Adjust RV2 for a DC voltage at TP2 that is midway between the muted and unmuted levels on the violet wire. Example: If the violet wire goes from 0 volts (muted) to 5V (unmuted) adjust RV2 (TP2) for 2.5VDC and program mobile COR as active high. If the violet wire goes from 3.5V (muted) to 0.7V (unmuted), adjust RV2 (TP2) for 2.1 VDC and program mobile COR as active low.

Pin 8 : (Brown) Audio mute output. Whenever the model 2012 is receiving a signal, this line will pull to ground to mute the receiver audio. When not receiving, it is open collector. If you wish to use tone stripping, connect this line to an *active low* audio mute input to the radio, or more generally, to the high side of the volume control.

Pin 9 : (Grey) **Mic mute:** This line goes *active low* every time the model 2012 sends it's message and may be used to mute the microphone audio to prevent interference with the tone signal.

Channel Select: This line goes active low at the beginning of the message and remains low until an acknowledgment is received, the number of retries expires or the user presses RESET. It can be used to automatically select a different channel for data transmissions and automatically revert back to a voice channel.

The function of the pin is under software control. See programming section under system data.

P2 (DB9-F) Connector

Pin 1: Ground. Connect to the ground reference of the auxiliary device.

Pin 2: RS-485 "-" lead

Pin 3: RS-485 "+" lead

Pin 5: Switched B+ output, 1A fused, to supply auxiliary device

Pin 9: This is the horn honk output. It is active low and will provide a switch to ground capable of driving a horn relay coil. It is rated at 2A, 12VDC.

Mounting Bracket

The supplied mounting bracket is attached to the model 2012 via 4 screws, and may be mounted in any of the four directions for optimum flexibility. Alternately, the model 2012 may be flush mounted to any flat surface using the 4 supplied mounting screws.

Do not use screws other than those supplied to attach the 2012 to the mounting bracket. If screws longer than 1/4" are used, damage to internal circuitry may result.

Mount the unit in an area that is easily accessible to the driver (and technician) that does not allow direct sunlight to easily shine on the unit. Do not mount the 2012 in a location that obstructs the drivers view or poses a potential hazard to the driver in the event of a vehicle collision.

Alignment

Before aligning the 2012, ensure that the mobile radio is aligned per the manufacturer's service procedure; Ensure that the 2012 is properly programmed. In order to properly align the 2012, you will need a service monitor and the mobile radio that the 2012 will be installed with.

Dis-assemble the MDT by removing the two cap screws on the left side panel. Carefully slide the entire assembly out of the housing noting that the flex cable connecting the keypad is in place. Connect the service monitor to the mobile antenna jack. Connect the cable from the mobile radio to the 2012.

Transmit Deviation: Press and hold the "F2" button while turning on the radio. This will put the unit into the Test Setup mode. Press the "1" key to select "Set Deviation".

MSK mode: If programmed for MSK mode, the 2012 will send alternating 1's and 0's until the RESET key is pressed. Adjust **RV3** for 60% of rated system deviation. Compare the service monitor display with the waveforms on page 9; the transmitted signal should resemble the sine waves as shown. If excessive distortion is occurring, you may need to find a different point in the radio. Press the RESET key once to return to main test menu.

DTMF mode : Press and hold the "0" key and adjust **RV3** for 60% of rated system deviation. Release the "0" key and press the RESET key once to return to main test menu.

Receive Sensitivity: Set the service monitor signal generator for the mobile's receive frequency, with 60% deviation of a 1kHz tone. Connect an oscilloscope or AC voltmeter to **TP1** and adjust **RV1** for 1VPP as read on the scope, or 375mVrms on the meter.

If programmed for DTMF, select menu item 2, turn off the 1kHz tone and enable the DTMF encoder. Any DTMF digits sent to the 2012 should be displayed on the LCD. Ensure all DTMF digits are decoded. Pressing the "CLEAR" key will erase the bottom display line.

The DTMF decoder works at full speed and can be used to receive and display status requests and acknowledgments from other mobiles and the base. If a 2012 is not handshaking properly with the base, set up another working 2012 in test mode and monitor the signalling to determine what is being sent and received.

Squelch Threshold: Measure and record the voltage on the violet wire when the mobile is receiving and when it is squelched. Adjust RV2 for the mid-way point between the two voltages just recorded, with a voltmeter on TP2. The yellow LED (DS2) will light to indicate a busy channel. If DS2 is on when the channel is idle and off when busy, the COR polarity is programmed backwards. If DS2 is always on or always off, RV2 is improperly set or the violet wire is not connected to a point that indicates receive unmute.

Notes:

1200 Baud Test Waveform

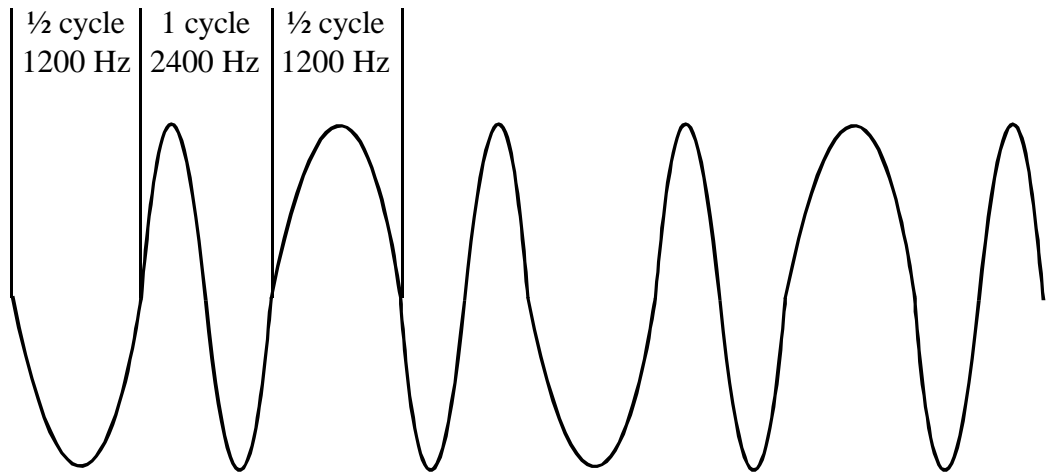
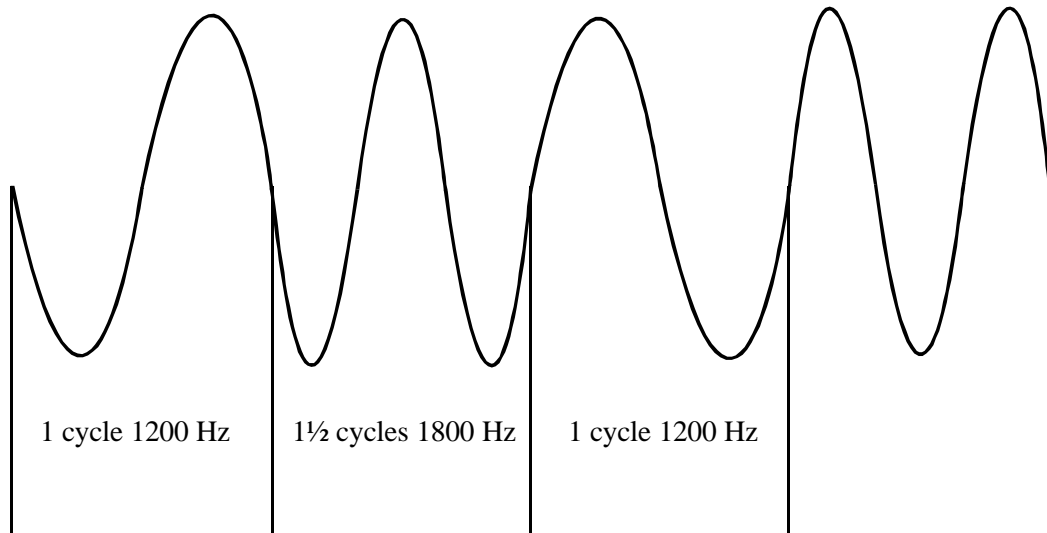

2400 Baud Test Waveform

Programming

Note to DOS 6.0 and higher users: The memory manager automatically installed by DOS 6.0 and greater, defaults to a configuration that does not allow access to extended memory. The Model 2012 program needs access to extended memory and will not run if your computer disallows it. If you receive the error message:

"Program too big to fit into memory" or "not enough memory"

You must edit your autoexec.bat file. Add the following line:

```
SET CLIPPER=F50;E000
```

Save the file and reboot your computer.

Using the Software

The 2012 personalization software is used to program the 2012 for all of the operating parameters and options. The software is menu driven and on-line help is available at any time by pressing F1.

To install the software on your computer type the following at the DOS prompt:

```
A:INSTALL or B:INSTALL
```

The install program will install the software onto your hard drive in a directory called 2012. To run the program, type:

```
2012
```

The main menu bar will appear at the top of the screen, with the highlight on "FILE". Press <ENTER> or the first letter of any of the main menu bar items to activate a drop down menu of choices (clicking the left mouse button on any of the main menu bar items will have the same effect). When the drop down menus are displayed, any of the sub-menu items may be selected in the same way: by pressing the first letter of the item, by moving the highlight with the up/down arrow keys and pressing <ENTER> or by clicking the left mouse button on the desired item.

There is on-line help available at any time by pressing F1, or by clicking the left mouse button on the [HELP] icon in the upper right corner of the screen. Use the up/down arrow keys, pgup/pgdn keys or home/end keys to move through the help text. Pressing <ESC> or the right mouse button returns to normal program execution.

Important Note:

Before attempting to program the 2012 start the software and ensure the FY-1 programming cable is plugged into the correct serial port. The com port may be selected under the "FILE" menu. Plug the FY-1 programming cable into P4 under the right side panel (you need to remove the panel first) of the 2012. Press and hold the "F1" button while applying power. The display will indicate "Program Mode":

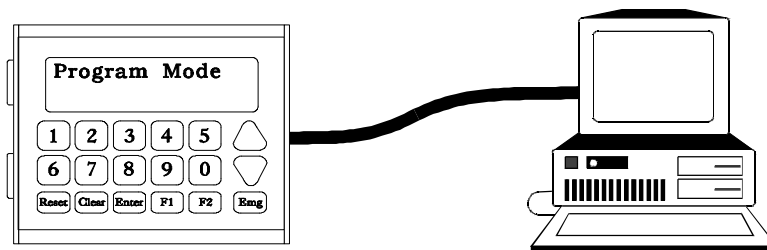

Menu selections

File

Load: Allows you to load a previously saved file from disk. Enter the file name or press F2 for a directory of 2012 files. Only files with the .MDT extension and legal DOS names will be loaded.

Save: Allows you to save the current configuration to disk. Enter the file name to save or press F2 for a directory of 2012 files. The file name entered under the common data menu is automatically inserted for file name to save. This name is also stored in the E²PROM of the 2012 during write operations and will be the inserted file name if the radio data has just been uploaded. The program will prompt you before overwriting an existing file.

Com1/2: Allows you to change the com port setting for uploads and downloads to the radio. This setting is remembered by the program for the next session.

Print: Sends the current configuration to LPT1. Make sure the printer is on line and paper is loaded before executing this command.

Quit: Returns to DOS. You will be asked to confirm before exiting the program. The software will also prompt you if the configuration has changed since program start up and data has not been saved to disk.

Data

Format: Three choices regarding the signalling format are presented.

DTMF 18 DPS Speedcall® 912C Compatible
1200 Baud MSK
2400 Baud MSK

System Data: The data that pertains to the vehicle addressing, type of mobile used as well as specific parameters used with different manufacturers of mobile radios.

Vehicle #:	This is the vehicle number in the fleet. Range is 000-999 (DTMF mode) or 00000-65534 (MSK mode).
Base #:	This is the base console the mobile is assigned to. The mobile will send its status requests to, and receive base messages from, only this console. Range is 1-4 (DTMF mode) or 1-15 (MSK mode).
PTT Delay (.1-2.5 Sec)	The delay from when the transmitter is keyed until the first digit is sent is based upon this timer.
Retries (0-9):	Number of additional attempts the 2012 will go through if no acknowledgment is received. You should always program at least 1 or 2 retries to prevent call queuing on a failed status request. Excessive retries may indicate mis-alignment of the 2012, the 2016 modem or the radios they are connect to.
Trunking Mobile: Yes/No	If programmed for trunking operation, the 2012 will go through the smart voice channel acquisition sequence rather than simple PTT delay.

Sequential Status: Yes/No	If set to yes, the operator must press the status buttons in sequence with the following exceptions: 1, 9, 0 and EMG may be pressed anytime. 2 may be pressed after 1 or 8.
ANI on mobile PTT: Yes/No	If enabled, the 2012 will send an ANI burst whenever the mobile is keyed by the operator. ANI allows the dispatcher to identify who is transmitting in the fleet at any given time. Also useful for logging transmissions.
Enable Time Stamp: Yes/No (DTMF mode only)	If this selection is enabled, a time code is sent along with the status information indicating at what time the button was pressed. If the mobile is out of range of the base, the 2012 will queue the keypresses and save the time that the button was actually pressed for transmission when the vehicle is back in range.
GPS Interval: 1-15 minutes (MSK mode only)	Sets the time interval between automatic reports of the GPS receiver. Requires installation of an optional GPS receiver board. See pages 14 and 15 for details.
COR Polarity: Low/High	Determines whether the violet wire (pin 7 mobile COR detect) is active high or active low. RV2 is used to set the COR threshold. See page 8 for alignment instructions.
On Air Polarity: Low/High	Determines whether the blue wire (pin 3) is active high or low. On conventional radios, this may be the same as mic PTT and is used for ANI trigger. On trunking radios, this line must be attached to a point that actually indicates the mobile is transmitting (TX B+).
I/O Pin 9: Mic Mute/ Ch Sel	The gray wire (pin 9 main connector) can be programmed for mic mute or channel select. If programmed for mic mute, pin 9 will go low only while the 2012 is sending tones. If programmed for channel select, pin 9 will go low at the beginning of each message and remain low until an acknowledgment is received, the user presses RESET, or the number of retries expires. This can be used to send the status messages on a separate data channel.
Method: Pulse/ Continuous	If channel change function is selected for I/O pin 9, this determines if the output is held active for duration of the status request or pulsed once at the beginning of the request and again at the conclusion.

Alpha Tags: This menu selection will allow you to customize the buttons 0 through 9 on the keypad as they pertain to the system used.

Transfer

Send: Downloads the current configuration to the MDT. The program will prompt you to make the FY-1 connection and press the <SPACE> bar to begin downloading.

Receive: Uploads the current data from the MDT. The program will prompt you to make the FY-1 connection and press the <SPACE> bar to begin uploading.

Help

There are two help menu items: **General** explains how to use the mouse and menu system as well as general program information. **About** contains Pyramid's address and phone number for problems that may arise. Help is also available at any time by pressing F1 or clicking the left mouse button on the [HELP] icon in the upper right hand part of the screen.

Test Modes

There are 4 test modes built into the 2012 used for alignment and verification. To enter the top level test menu, press and hold the **F2** key while applying power. The LCD display will rotate between the 4 choices; press keys 1-4 to access the following test modes:

1. Set Deviation: Pressing the 1 key will enter the deviation test mode.

DTMF mode: Pressing any numeric button on the keypad will key the mobile radio and send DTMF for as long as the button is held and echo the keypress on the bottom line of the LCD. Releasing the button will unkey the radio. Press the **RESET** key once to return to the main test menu.

MSK mode: The 2012 will send alternating 1's and 0's until the **RESET** key is pressed. Adjust **RV3** for 60% of rated system deviation. Compare the service monitor display with the waveforms on page 9; the transmitted signal should resemble the sine waves as shown. If excessive distortion is occurring, you may need to find a different point in the radio. Press the **RESET** key once to return to main test menu.

2. DTMF Rx Mode : Pressing the 2 key will enter the DTMF decode mode. Any DTMF received by the mobile will be displayed on the bottom line of the LCD. Pressing the **CLEAR** key will erase the bottom line of the LCD and pressing **RESET** will return to the top level menu.

The DTMF decoder works at full speed and can be used to receive and display status requests and acknowledgments from other mobiles and the base. If a 2012 is not handshaking properly with the base, set up another working 2012 in test mode and monitor the signalling to determine what is being sent and received.

3. GPS Test mode: Pressing the 3 key will enter the GPS receiver test mode and display the latitude and longitude of the 2012 along with speed and heading after a short acquisition period. If a GPS module is installed, the display should indicate "Find satellites" for 30-60 seconds. The GPS board must locate at least 3 satellites to compute a position fix. Once the satellites have been identified, the display will change to "Compute location" for 2-3 minutes. After a position fix has been acquired, the latitude and longitude, speed and heading information are updated once each second. Pressing the **RESET** key will return to the top level menu.

4. EPROM Readout: Displays the contents of internal registers for statistical data and system trouble shooting. Pressing the **RESET** key will return to the top level menu. *NOT IMPLEMENTED IN CURRENT FIRMWARE.*

Notes:

GPS

The GPS option uses an Ashtech G8 receiver board and is installed on the back of the main 2012 PCB. The GPS board communicates with the 2012 μ P via a two wire serial port. A right angle SMA connector is provided on the left hand end panel for connection to the GPS antenna.

When the 2012 is powered up, it will look for the GPS receiver and auto-detect if it is installed. If a GPS receiver is present, the 2012 will program the receiver for the proper baud rate and operating parameters. The GPS icon () will indicate if the receiver is installed and the 2012 μ P was able to access it. If a GPS antenna is connected, the receiver will go through its position acquisition process which can take from 2-4 minutes depending upon signal strength and vehicle speed (the receiver can acquire position lock faster if the vehicle is not moving).

In normal operation, the 2012 will query the GPS receiver for its position fix on the programmed interval (1-15 minutes). If the receiver indicates a positive position fix, the GPS LCD icon will change to the satellite dish () and the 2012 will send its position to the 2016 base modem. The modem does not send an acknowledgment. The 2016 modem can poll the 2012 for its position at any time from the dispatch software (F2, poll GPS).

In test mode (hold F2 will applying power, then select '3 GPS test') the 2012 will query the GPS receiver once every second for its position fix. The LCD display will report the status of the acquisition process as follows:

Find Satellites : The 2012 has auto-detected the GPS receiver but no satellites have been acquired (minimum of 3 needed for a position fix).

Compute Position : The receiver has acquired 1 or more satellites but is still computing its location.

When a position fix has been acquired, the 2012 will show it's latitude and heading on the top line of the LCD and the longitude and speed on the bottom line of the LCD.

If the GPS receiver does not acquire position lock, or the 2012 does not auto-detect the receivers presence, the FY-1 programming cable can be used to observe the communications between the 2012 and the GPS receiver. Plug the FY-1 into P4 behind the right hand side panel and connect to a PC running Procomm® or some other terminal program. Set the terminal program for 9600 baud, No parity, 8 bits, 1 stop bit.

When the 2012 is first powered up, the GPS receiver is operating at 4800 baud. The first command sequence from the 2012 to the GPS receiver is to change the baud rate to 9600 baud and will appear as "garbage" on the PC screen (which is already at 9600 baud). The 2012 will then send the NMEA Recommended Minimum Course query message (RMC) on the programmed interval (normal mode) or every second (test mode). The query message should appear as follows:

```
$PASHQ,RMC
```

The GPS receiver should respond within 1 second with one of the following:

```
$GPRMC,,,,,,,,,,*67          {No satellites acquired, all data fields blank}
```

```
$GPRMC,172926.00,V,,,,,,,,,200799,,*17 {Satellites acquired no position fix}
```

```
$GPRMC,172926.00,A,3344.59095,N,11802.32305,W,000.1,000.0,210799,013.8,E*44 {Position Fix}
```

The messages are standard NMEA0183 V2.1 ASCII character strings. The data displayed will vary depending upon date, time, and your position. The data fields are defined as follows:

```
$GPRMC,172926.00,A,3344.59095,N,11802.32305,W,000.1,000.0,210799,013.8,E*44
```

\$GPRMC:	Standard NMEA message header for GPS device, Recommended Minimum Course response.
172926.00	UTC time (Greenwich England) of position fix; format: hhmmss.ss.
V or A	Status: V indicates bad fix, A indicates valid data.
3344.59095	Latitude ddmn.mmmmm.
N or S	Latitude in reference to Equator.
11802.32305	Longitude dddmm.mmmmm.
E or W	Longitude in reference to Greenwich England.
000.1	Speed over ground, knots.
000.0	Course over ground, degrees true.
200799	Date (Greenwich England) format: ddmmyy.
013.8	Magnetic variation, degrees.
E or W	Direction of variation; E subtracts from true course, W adds to true course.
44	Hexadecimal checksum computed by exclusive ORing all bytes in message between '\$' and ''

You should not see any other messages from the 2012 or the GPS receiver (other than data content). If the GPS receiver board is sending other messages or it is sending messages without being queried (\$PASHQ,RMC) there may have been a problem at power up. The 2012 instructs the GPS receiver not to send any messages unless queried to do so. If the GPS board missed this message, it will send several messages automatically every second.

If the data displayed on the PC is all "garbage" the speed is most likely incorrect; change the PC terminal program to 4800 baud, no parity, 8 bit, 1 stop bit. This condition is caused by the GPS receiver missing the speed change request at power up.

In both of the above situations, communications between the 2012 and the GPS receiver may have been interfered with. The 2012 and GPS receiver communicate over the μ P serial bus which is also shared by P4 (programming connector) and the RS485 transceiver chip (U10). Ensure that no other devices are connected to either of these circuits (with the exception of the FY1 connected to P4) and check that no shorts or circuit damage are present .

In cases of high RF energy fields (100 Watts at low band or VHF frequencies) communication problems between the 2012 and GPS receiver may result. Ensure the 2012 is installed in the extrusion and control cables are properly routed away from antenna cables. It may be necessary to relocate the 2012 away from the antenna or anywhere strong RF fields may interfere with the operation.

Theory of Operation

General

All of the functions of the 2012 are under control of the microprocessor U8 which also contains the firmware operating system and interfaces to the rest of the hardware. Non-volatile data storage is contained in U11 (personalization data) and U14 (data messages).

DTMF Generation and MSK signalling

U3 provides the DTMF encoding and MSK encoding/decoding as well as signal filtering. The microprocessor communicates with U3 on pins 4 and 5. DTMF digits are selected by the micro, generated by U3 output on pin 23 then amplified by U1A. Level control is achieved with RV3. After amplification the audio is routed to the mobile radio for modulation.

DTMF Decoding

U9 is a DTMF decoder that takes audio from the mobile radio, filtered through a three stage noise and CTCSS filter and applied to pin 2. Audio level adjustment is made with RV1. U9 signals the μ P via pin 15 (active high) any time DTMF is being decoded. Pins 11-14 present the decoded digit to the microprocessor as binary data.

Audio processing

Audio enters the 2012 on pin 6 of P1 and is high pass filtered by U2A which has a cut off frequency of 300 Hz and a slope of 12db/octave. U2B and U2C are a 4 pole low pass filter with a cut off frequency of 2500 Hz and a slope of 24db/octave. The filtered audio goes into U3 pin 13 an op-amp inverter with a gain of 0-20db as determined by RV1. U3 pin 14 is the output which goes to the DTMF decoder U9 and to its internal MSK decoder. Transmit audio comes from U3 pin 23 (DTMF and MSK) is amplified by U1A and output on pin 2 of P1. RV3 sets the level and J1 selects the adjustment range; In:0-200mV Out: 0-5V.

LCD Display Driver

The μ P sends data to the shift register U12 in a serial format. 8 bits are clocked in then the latch enable pin of the LCD module is strobed to acquire it. The data can be an instruction to the LCD or data to be displayed. Contrast control is accomplished by a negative voltage supply U13 and a resistive feedback control consisting of R46 and R45.

RS-485 Driver

A communications bus which allows peripheral device such as a printer, expanded keyboard, bar code scanner and credit card reader to share the same two wires is the RS-485 bus. Each device on the bus has a unique address and will only respond to instructions with the proper addressing. Other activity on the bus is ignored. The U10 IC is a TTL to RS-485 driver which takes serial data from the microprocessor in on pin 1 and provides incoming serial data on pin 4.

Keyboard Decoder

The 18 button keypad as used on the 2012 is decoded by U7 IC. This chip will take the ROW and COLUMN lines of the keypad and present a 5 bit parallel word to the microprocessor. The decoder is monitored by the STROBE line indicating that a button has been pressed. Control of the output of the decoder is achieved by the OUTPUT ENABLE pin 14. The DTMF decoder and the keyboard decoder share the same data bus lines and the OE of each chip is used to select which device the microprocessor will read data from.

Memory Retention

Two on-board E²PROMS provide data retention of programming information, messages received and pending messages. U11 contains the programmed unit personality and U14 contains the stored messages. The E²PROMs have a data retention of up to 100 years without power applied. Each E²PROM communicates with the microprocessor with serial information on lines DATA IN and DATA OUT. The CHIP ENABLE pin allows the μ P to select which device to send and receive data.

Logic and control : U8 is an Atmel 89C52 microprocessor with flash E²PROM memory. The microprocessor provides all of the logic and control functions for the 2012, interface to the rest of the hardware and communications with the PC for programming.

The 89C52 has four 8 bit ports that interface with the rest of the hardware on board; a brief description of each port follows:

- P0.0 Serial data output to the E²PROMs and LCD display.
- P0.1 Serial Clock output to the E²PROMs and LCD display.
- P0.2 Audio mute output (tone stripping) active high.
- P0.3 PTT output active low.
- P0.4 IO pin 9 output (mic mute/channel change) active high.
- P0.5 Beep transducer output active low.
- P0.6 COR LED output active low.
- P0.7 Horn Honk output active low.

- P1.0 Chip Select for U3 MX829 active low.
- P1.1 Serial Data Input from U3 MX829.
- P1.2 Serial Data Output to U3 MX829.
- P1.3 Serial Clock for U3 MX829.
- P1.4 U11 E²PROM chip enable, active high.
- P1.5 Serial Data Input from U11 and U14.
- P1.6 RS-485 request/busy line.
- P1.7 Mobile COR input. Polarity is determined by programming.

- P2.0-4 Data Bus lines for U7 Keyboard decoder and U9 DTMF Decoder.
- P2.5 Strobe Output for U7 Keyboard Decoder active high.
- P2.6 Chip Enable for U14 E²PROM.
- P2.7 Output Enable for U7 Keyboard decoder (active low) and U9 DTMF decoder (active high).

Model 2012 Service Manual

INT0	External interrupt #0. Interrupt request from the MX829 MSK decoder.
INT1	On-Air Detect input used for ANI trigger and trunking channel smart voice channel access. Polarity is determined by programming.
T0	Data / Instruction Pin for the LCD display
T1	Latch Enable Pin for the LCD. This pin latches the date converted from the serial to parallel chip U12.
TXD	Transmit data output for programming. Data is sent to the PC on this line at 9600 baud, 8 data bits, 1 stop bit and no parity. This line is active during programming mode as well as data sent to peripheral devices on the RS-485 bus.
RXD	Receive data input for programming and RS-485 bus.. Data is received from the PC on this line at 9600 baud, 8 data bits, 1 stop bit and no parity. This line is active during programming mode as well as when data is received from peripheral devices on the RS-485 bus.
Reset	Active high input to reset the microprocessor. U11 provides a 350mSec delayed high signal to this pin during power up or if the 5V line falls below 4.5VDC.
Xtal	The microprocessor uses a 14.7456MHz xtal for all of the timing and program execution clock cycles.

Signalling

DTMF The outbound mobile message can be either 6 digits (normal operation) or 9 digits (time stamp):

Normal:	Digit #	Range	Function
	1	A-D	Destination Console
	2	A-D	A: Response to base originated message B: Dispatch request C: Mobile originated message D: Emergency message
	3	0-9	Vehicle ID MSD
	4	0-9	Vehicle ID
	5	0-9	Vehicle ID LSD
	6	0-9	Current Status (base originated) or status request (mobile origin)

Timestamp:	Digit #	Range	Function
	1	A-D	Destination Console
	2	A-D	A: Response to base originated message B: Dispatch request C: Mobile originated message D: Emergency message
	3	0-9	Vehicle ID MSD
	4	0-9	Vehicle ID
	5	0-9	Vehicle ID LSD
	6	0	Always 0
	7	0-9	Current Status (base originated) or status request (mobile origin)
	8	0-9	Timestamp MSD
	9	0-9	Timestamp LSD

The outbound base message is always 6 digits:

Digit #	Range	Function
1	0	Always 0
2	0-9	Vehicle ID MSD
3	0-9	Vehicle ID
4	0-9	Vehicle ID LSD
5	*	Always *
6	0-D,*,#	1-9: Status request acknowledgment 0: Interrogate *: Horn Honk #: Selective Call A-D: Reassign destination console

Examples: Mobile user #159 presses status #4; mobile message: AC1594; Base Response: 0159*4

Base interrogates unit #160 who is at status #6: 0160*0; Mobile Response: AA1606

MSK

The 2012 transmits and receives data packets at 1200/2400 baud and conforms to the MPT-1317 protocol for over-the-air signalling. A brief description of the MPT-1317 protocol and the 2012/2016 data messages follows:

MPT-1317

The MPT-1317 protocol consists of a data packet made up of preamble (bit reversals for receiver synchronization), a 16 bit sync word, a 6 byte address code word and 16 bits of CRC error correction data. If data bytes are attached, they are preceded by the same 16 bit synch word (preamble is sent only once), and followed by 16 bits of CRC:

Preamble	sync	address code word	16 bit	crc	sync data bytes	crc
16 bits	16 bits	48 bits	16 bits	16 bits	up to 128 bytes	16 bits

The minimum message length is 96 bits; at 1200 baud, transmission takes 80mS, at 2400 baud, 40mS.

2012

The 2012 sends 2 types of messages that conform with the MPT-1317 data protocol. Status messages contain preamble, sync, address code word, and crc. GPS messages contain the same, plus add another 16 bits of sync, 64 bytes of data and 16 more bits of crc for a total of 640 bits. At 1200 baud, transmission takes 533mS, at 2400 baud, 266mS.

2016

The 2016 sends 2 types of messages that conform with the MPT-1317 data protocol. Status acknowledgment and paging messages contain preamble, sync, address code word, and crc. Alpha data messages contain the same, plus add another 16 bits of sync, 64 bytes of data and 16 more bits of crc for a total of 640 bits. At 1200 baud, transmission takes 533mS, at 2400 baud, 266mS.

Address Code words

The address code word defines the message type and what action is to be taken by the 2012 or the 2016. The address code word is 6 bytes of hexi-decimal data and conform to the following format:

Address Code word 6 bytes 48 bits:

- Bit 0 Always 1
- Bits 1-3 System Flags
- Bits 4-7 Console ID
- Bits 8-23 Mobile ID
- Bits 24-31 Function Code
- Bits 32-39 Time Stamp
- Bits 40-47 Number of data bytes to follow

Parts List

Reference	Description	Part #
BZ1	Beep transducer	6400-03-0501
C1	2200 pfd 805 Capacitor	1010-03-5222
C2	3300 pfd 805 Capacitor	1010-03-5332
C3	1000 pfd 805 Capacitor	1010-03-5102
C4, C25, C26	Capacitor, 100uF 16VDC Elect	1410-09-6107
C5, C9, C13, C15, C27, C30	0.1 µfd 805 Capacitor	1010-03-5104
C6, C24	0.01 µfd 805 Capacitor	1010-03-5103
C7	6800 pfd 805 Capacitor	1010-03-5682
C8, C18, C19, C31, C32	1 µfd 1206 Tantalum Capacitor	1610-05-6105
C10, C14, C17, C28, C29	2.2 µfd 1206 Tantalum Capacitor	1610-05-6225
C11, C12, C20, C21, C22, C23	22 pfd 805 Capacitor	1010-03-5220
DS1	16X2 LCD display	4102-32-0216
DS2	Yellow LED	4010-01-0281
D2, D4, D5, D6	BAV99 dual diode	3110-01-0099
D3, D7	1N4001 1A silicon	3110-11-4001
F1, F2	Fuse, 1A	2600-05-0010
P1	DB9-M Connector	7401-00-0011
P2	DB9-F Connector	7409-00-0011
P3	0.100" 9 pin Header	7301-14-0109
P4	2.5mm Jack	7401-02-0050
P5	2mm 8 pin Header	7300-44-0108
Q1, Q7	2N4403 pnp sot-23	3010-01-4403
Q2	FMMT38CT npn darlington sot-23	3010-01-0038
Q3, Q4, Q5	2N4401 npn sot-23	3010-02-4401
Q6	FCX491 npn sot-89	3010-06-0491
RV1	Potentiometer, 100K	2060-08-5104
RV2, RV3	Potentiometer, 20K	2060-08-5223
R1, R2, R3, R4	24K 0805 chip resistor	2010-03-5243
R5, R34, R35, R36, R37, R38, R39, R41, R49	2.2K 0805 chip resistor	2010-03-5222
R6, R14, R15, R16, R17, R18,		
R19, R20, R29, R30, R40	10K 0805 chip resistor	2010-03-5103
R7, R8, R9, R12, R13, R21, R32, R48, R50	22K 0805 chip resistor	2010-03-5223
R10, R46	47K 0805 chip resistor	2010-03-5473
R11, R23, R24	1K 0805 chip resistor	2010-03-5102
R22	120K 0805 chip resistor	2010-03-5124
R26, R27, R43	1M 0805 chip resistor	2010-03-5105
R28, R31, R33	100K 0805 chip resistor	2010-03-5104
R42	330 0805 chip resistor	2010-03-5331
R45	120 0805 chip resistor	2010-03-5121
R47	4.7K 0805 chip resistor	2010-03-5472
TP1	Test Point	7300-13-0001
U1	LM2904 Dual Op Amp	3410-01-2904
U2	MC3403 Quad Op Amp	3410-01-3403
U3	MX829 MSK Processor	3710-01-0829
U4	DS1833-10 Reset Controller	3400-07-1833
U5	LM78L08 8V Regulator	3410-10-7808

Model 2012 Service Manual

U6	LM7805 5V Regulator	3400-08-7805
U7	74C923 keyboard encoder	3510-01-0923
U8	AT89C52 μ P	3610-02-8952
U9	8870 DTMF Decoder	3410-01-8870
U10	MAX483 RS-485 Driver	3410-01-0483
U11	93C56 Serial E ² PROM	3610-01-9356
U12	74HC164 Shift Register	3510-01-0164
U13	MAX 853 Voltage Inverter	3410-01-0853
U14	93C66 Serial E ² PROM	3610-01-9366
VR1	MOV Surge protector 18V	2580-02-0018
X1	3.58MHz Crystal	6010-01-3579
X2	14.7456MHz Crystal	6010-01-1474
X3	4.032MHz Crystal	6010-01-4032

Extruded aluminium case	8100-01-2012
Aluminium end panel (left)	8200-04-2121
Aluminium end panel (right)	8200-04-2122
Keypad assembly	7000-01-0405
10ft. radio cable with DB-9F conn. ...	7500-10-1001
Mounting bracket	9600-05-2123
8-32 x 1/4" SS philips	8000-24-8324
4-40 x 3/8" SS cap screw	8000-34-4406
4-40 SS nut	8000-54-4400
4-40 x 1/4" SS philips	8000-24-4404
2-56 x 3/16" SS philips	8000-24-2563
2-56 x 1/8" aluminium spacer	8000-65-2562
Aluminium heat sink	8400-05-0003

Optional items:

SMA Right Angle Connector	7401-02-0003
---------------------------------	--------------

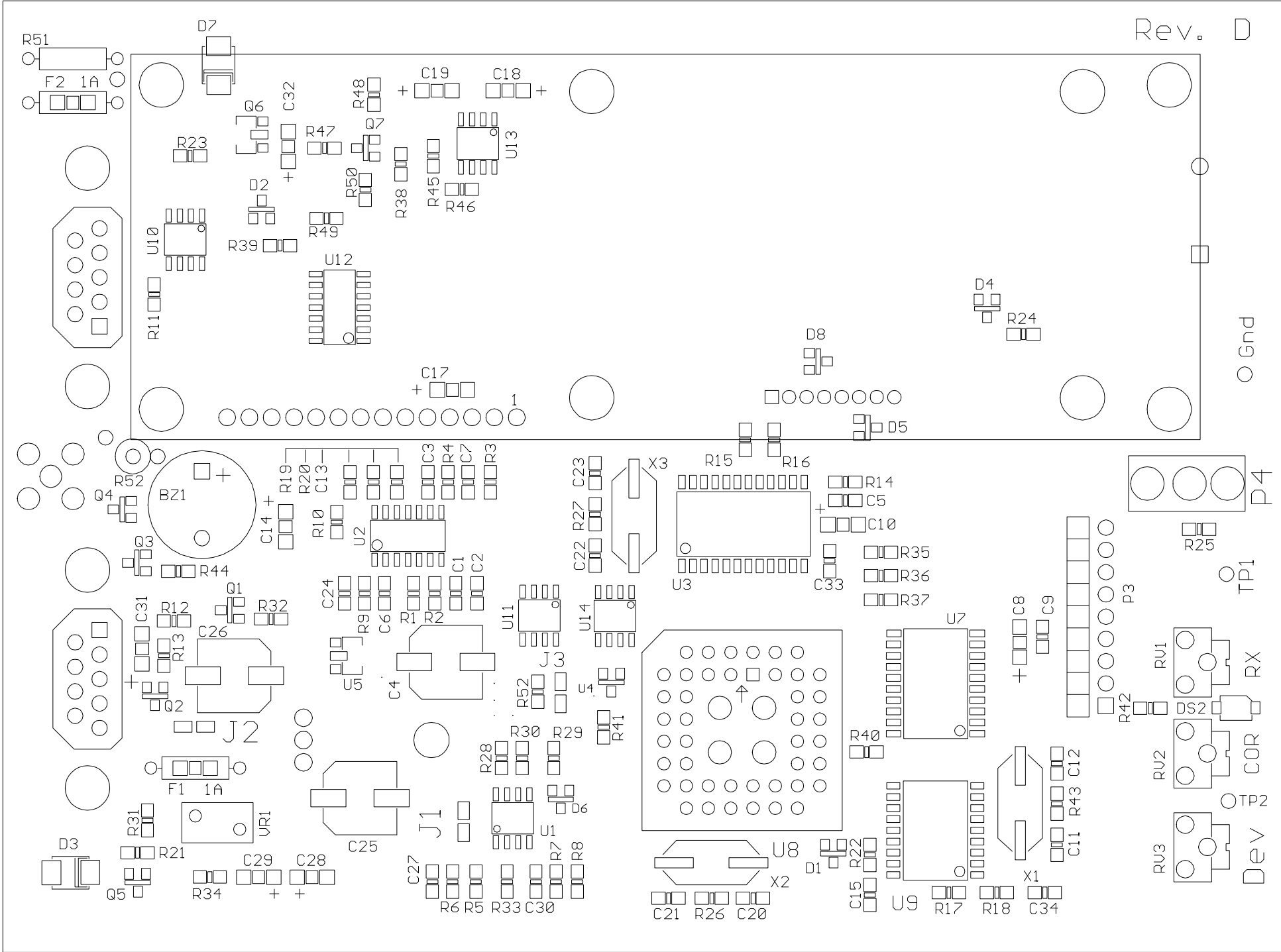

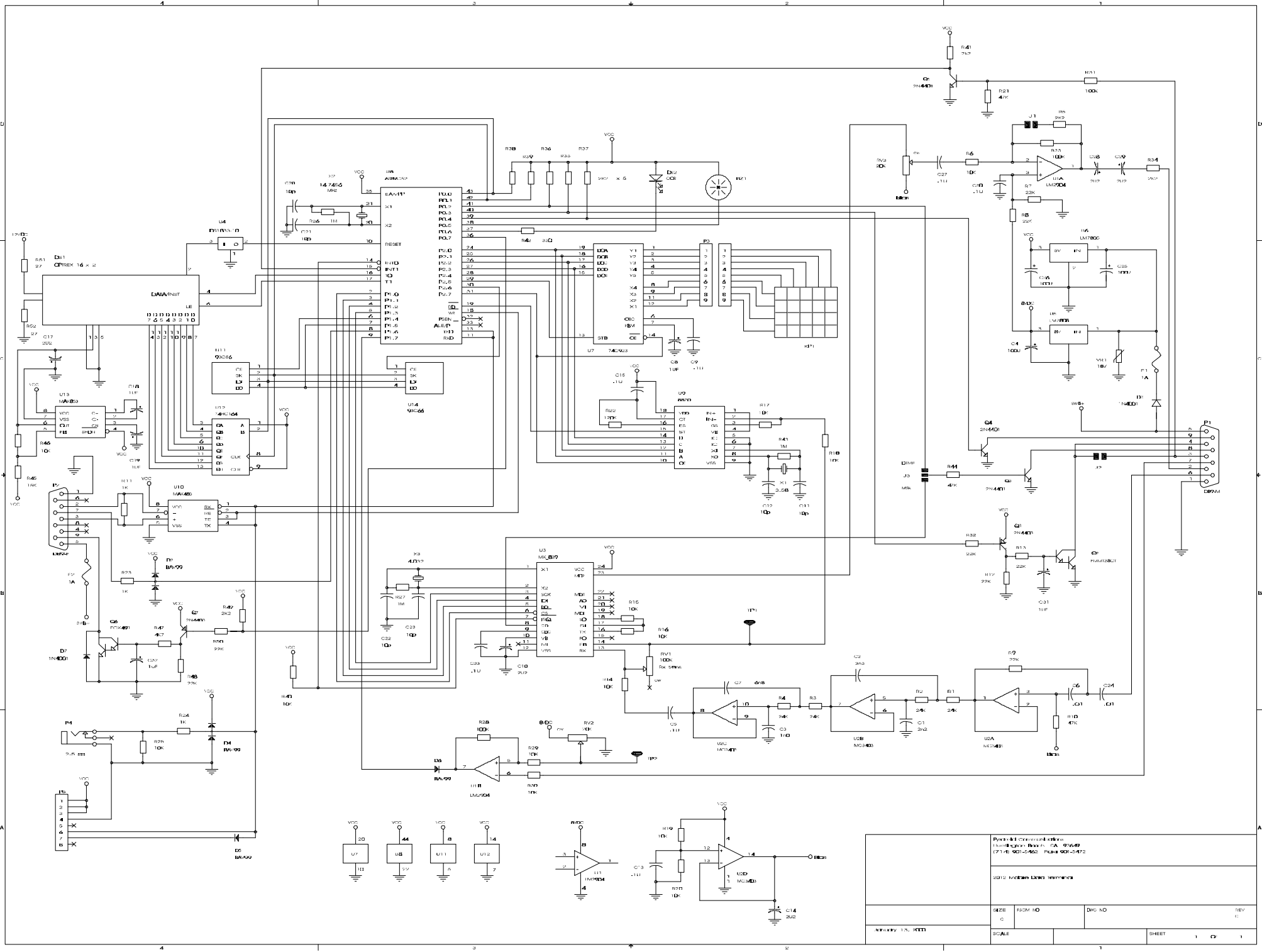

Pinesoft Electronics 11000 Sycamore Blvd., CA 91649 (714) 901-5002 Fax: (901) 5472			
8012 Mobile User Interface			
DATE C	FROM NO C	DWG NO C	REV 0
SCALE		SHEET 1	OF 1